

**Thule Smart Panels:
Sun Blocker Side for TO 1200
Rain Blocker Side for TO 1200 V2**

➤ Instructions

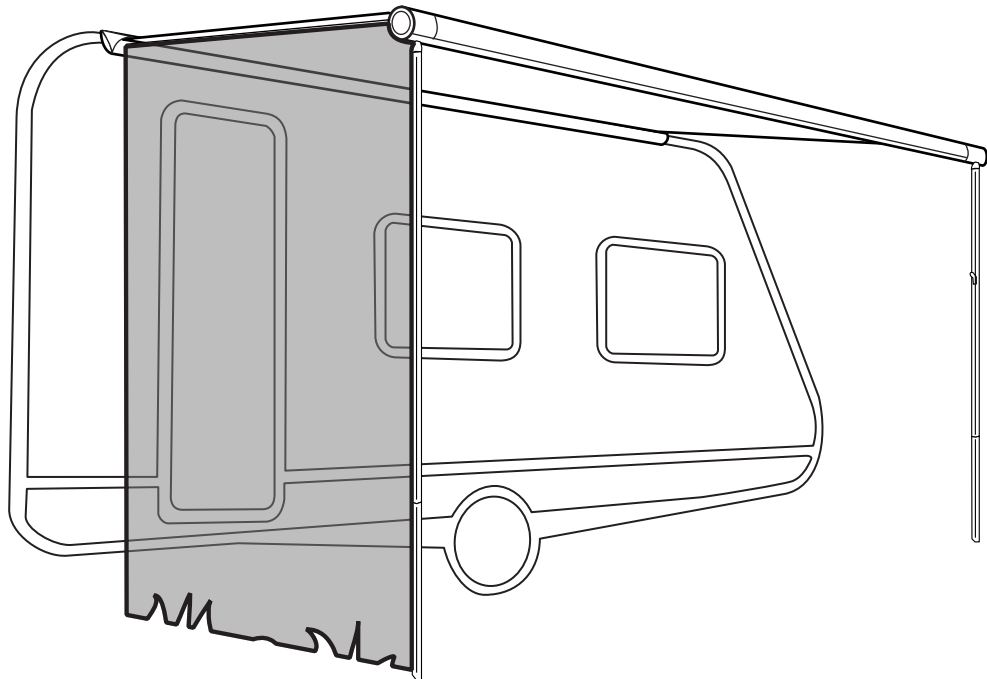



Thule Sun Blocker Side

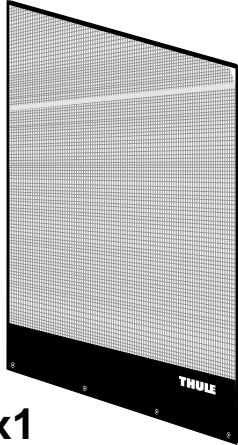
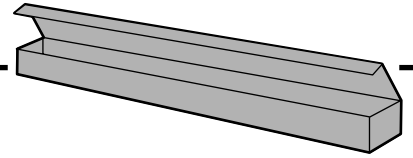

x1

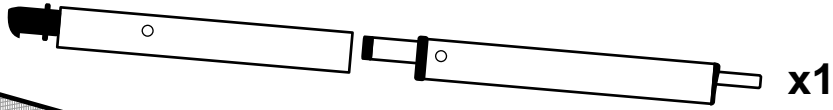

x1

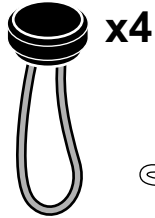

x4

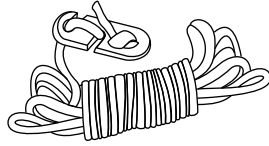

x4



x4

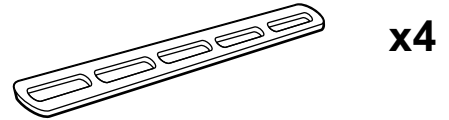

x4



Thule Rain Blocker Side

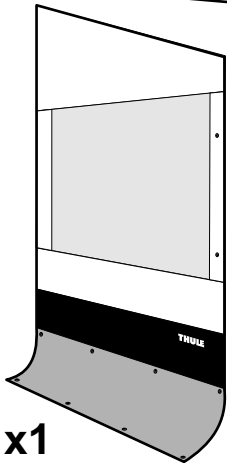
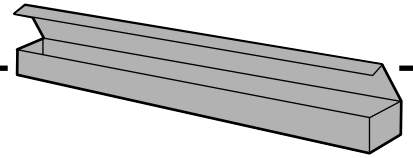

x1

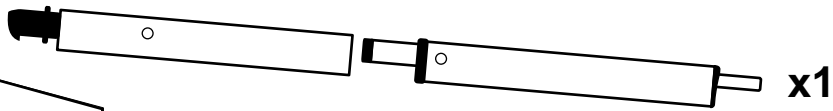

x1

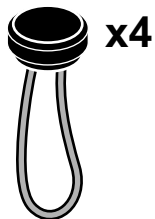

x4

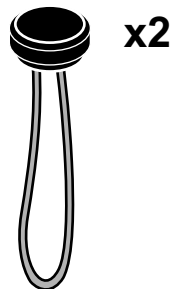

x2



x4



x4

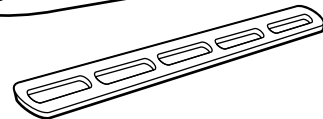

x4

1

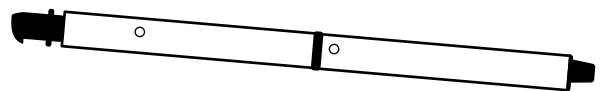
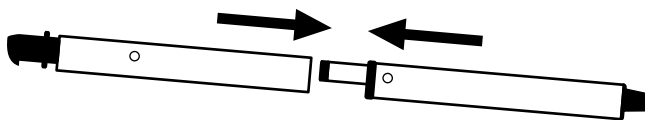

i

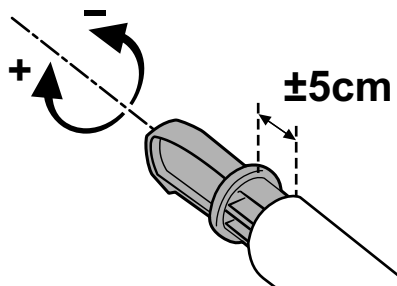

2

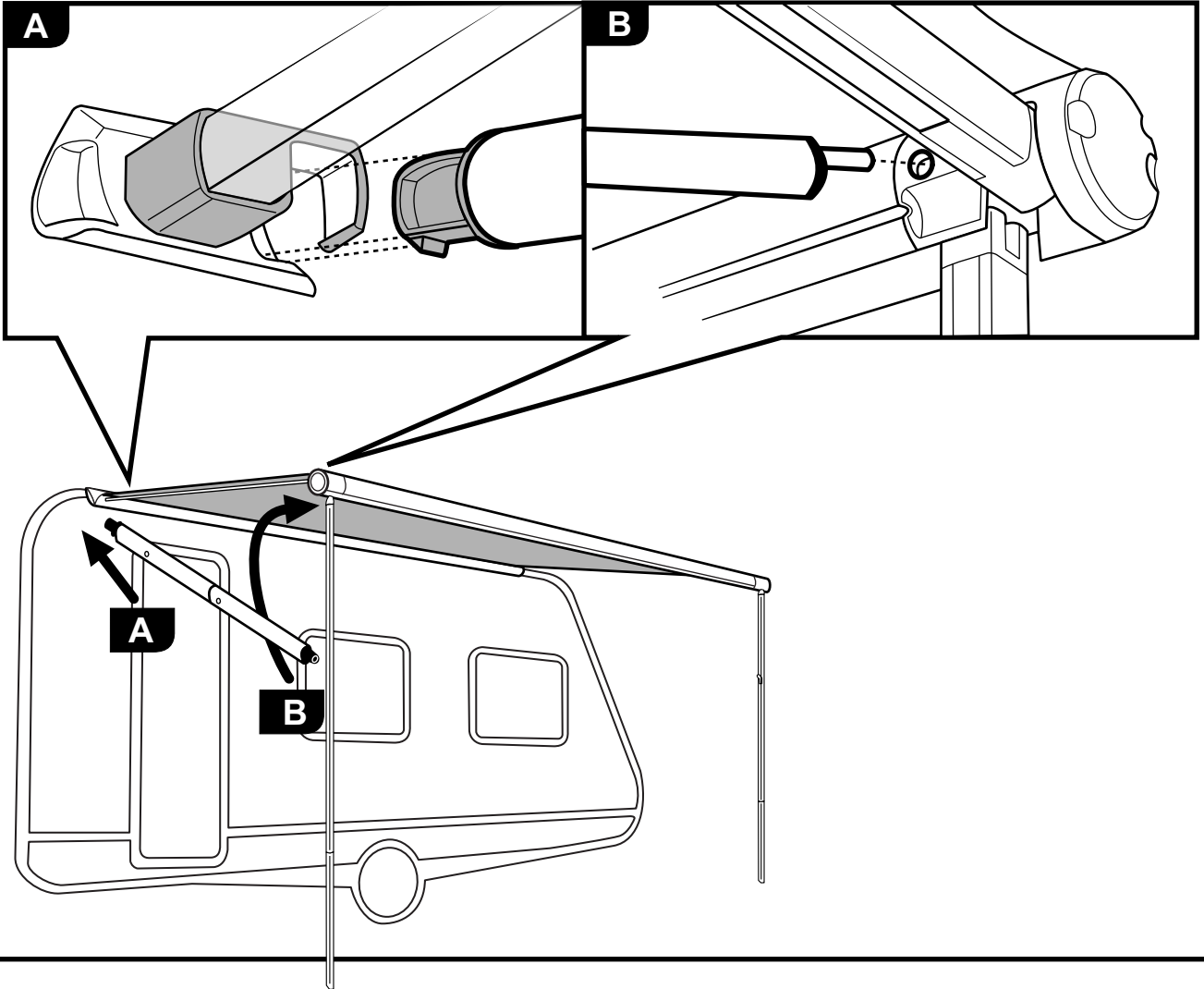

3

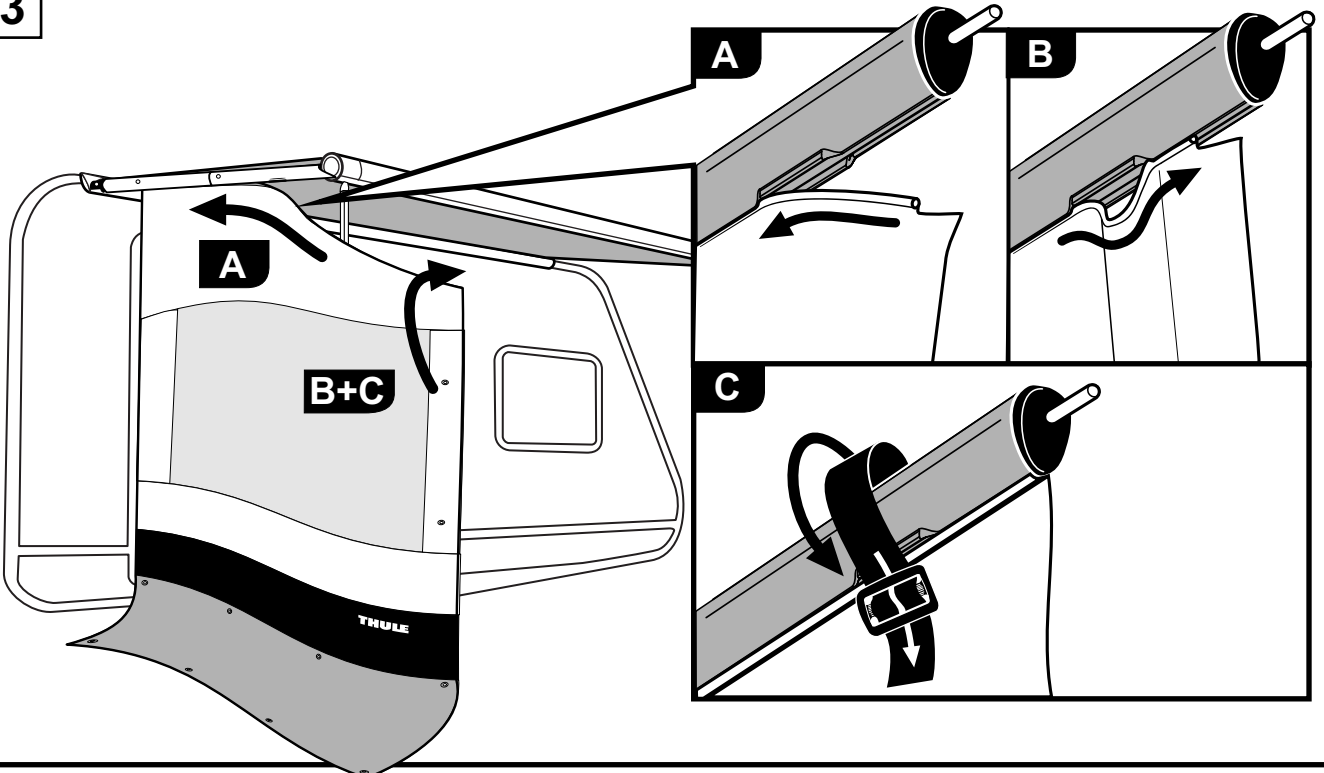



Thule Sun Blocker Side

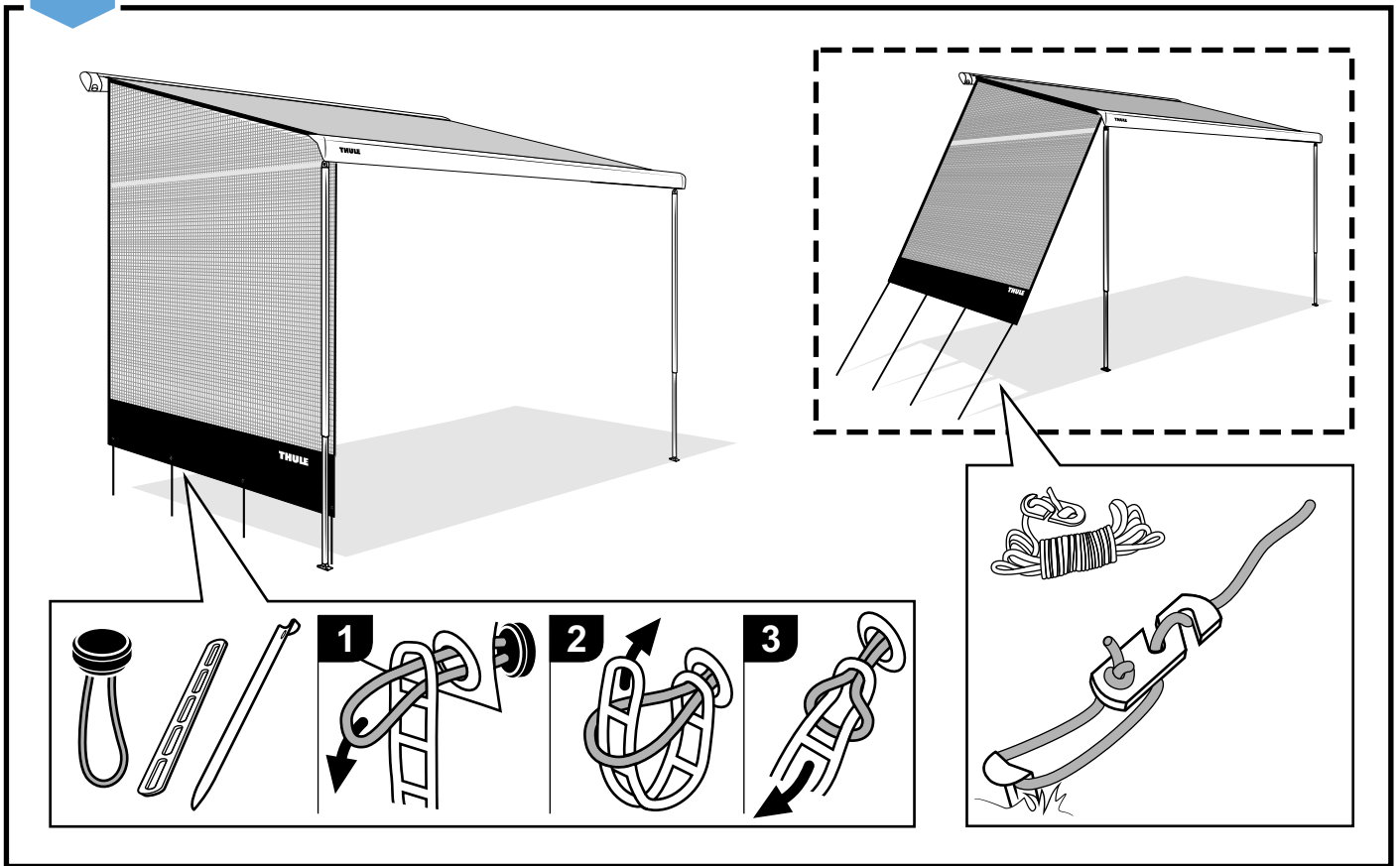

Thule Rain Blocker Side

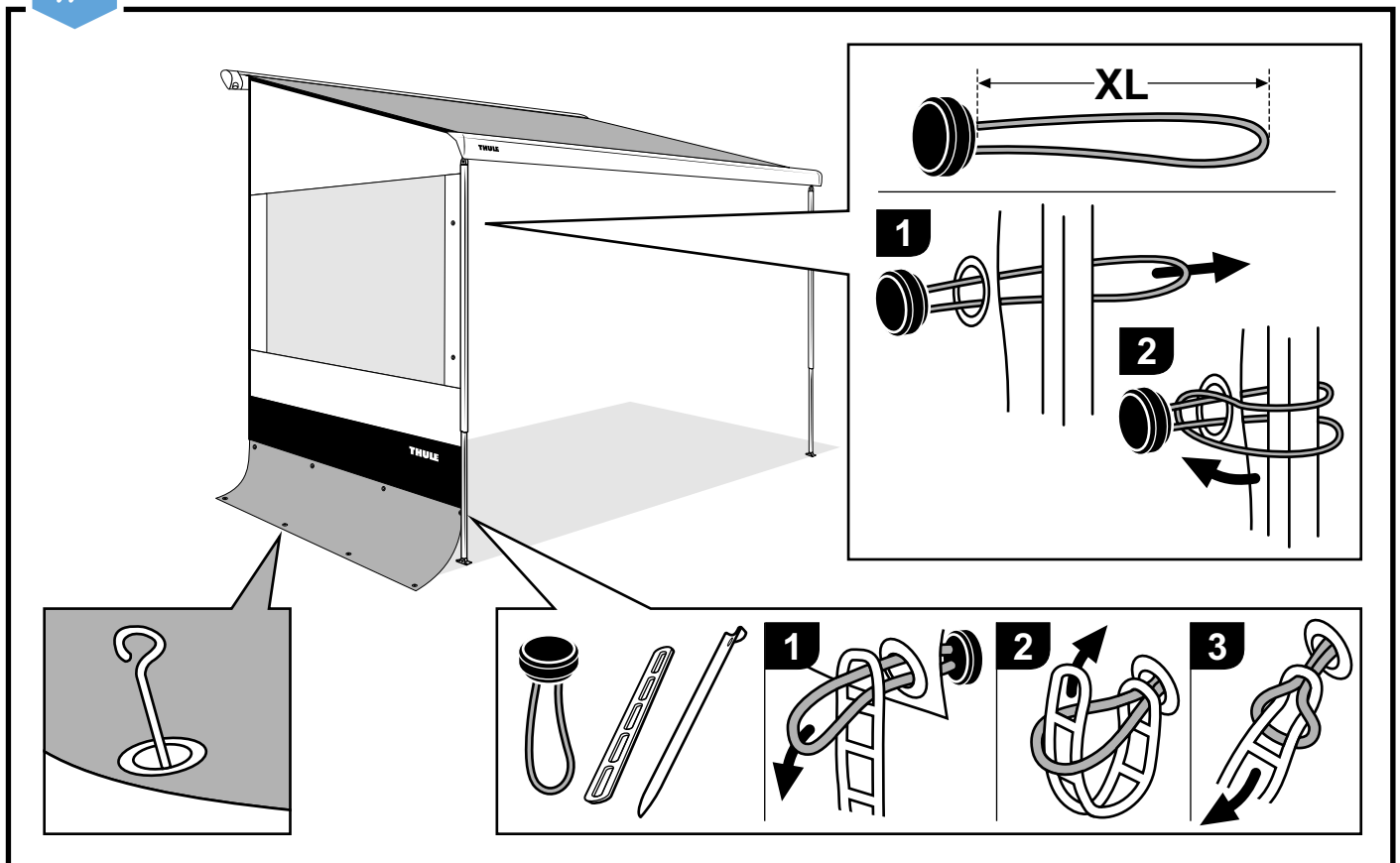

Smart Panels: some possible combinations

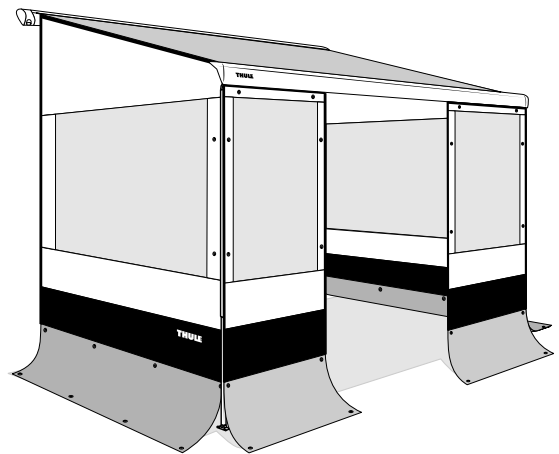
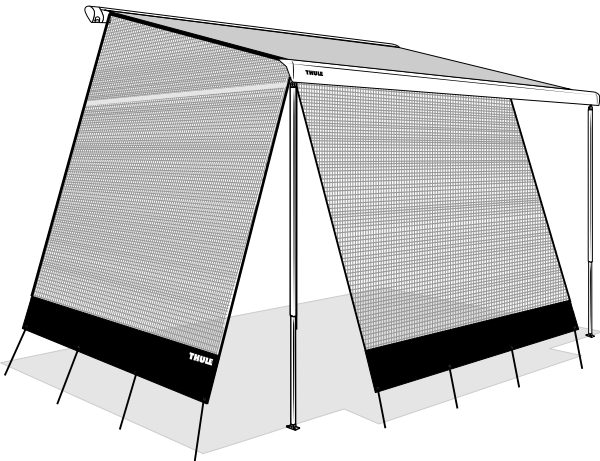
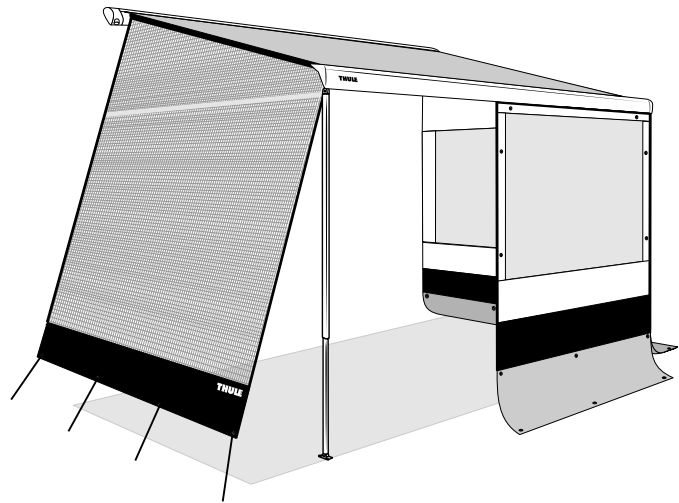
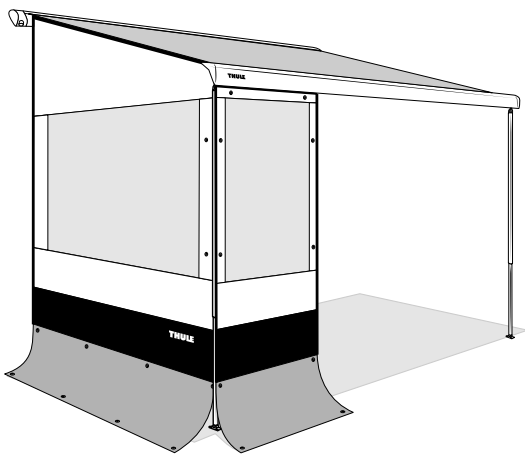
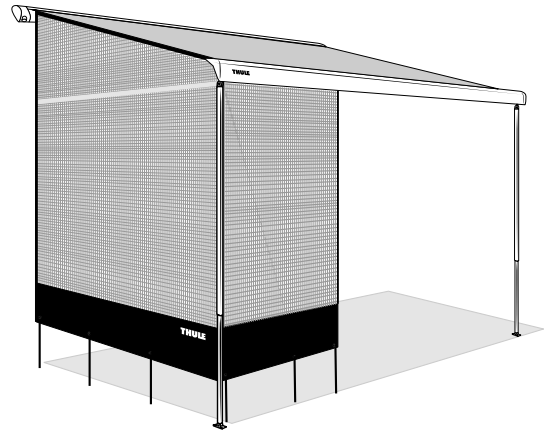
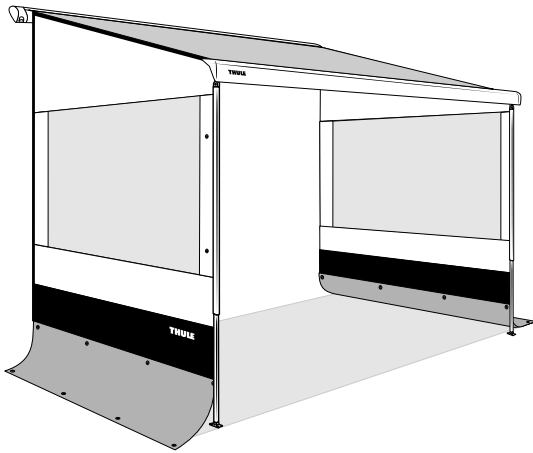

Front

**G2 Rain Blocker
G2 Sun Blocker**

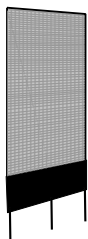
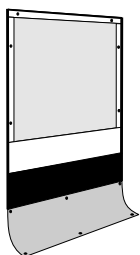

Side

**G2 Rain Blocker
for TO1200**

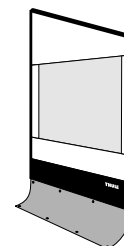

Smart Panels: some possible combinations

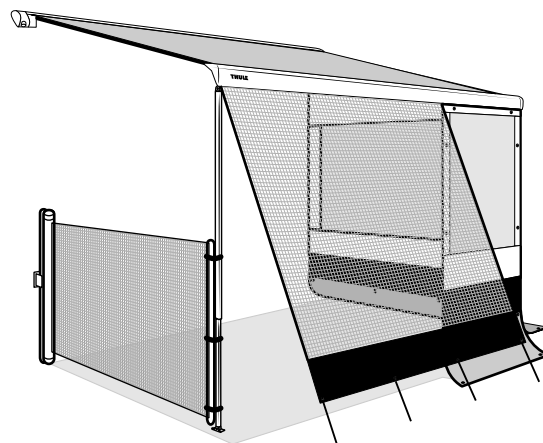
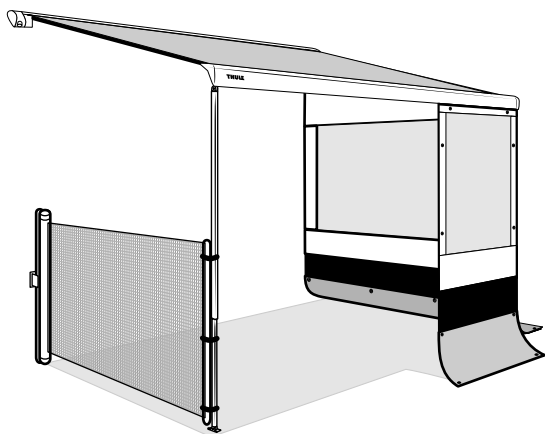

www.thule.com

306456

Windscreen

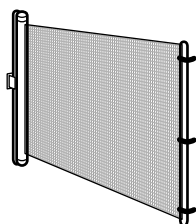

Tent

QuickFit



Thule Rain Blocker Front G2

Combinations for full awning length

Small

In combination with side panel TO1200 V2

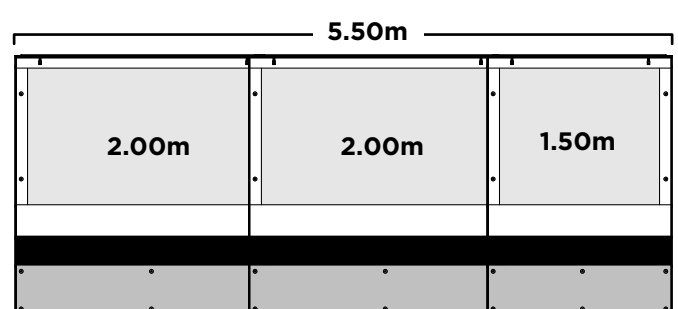
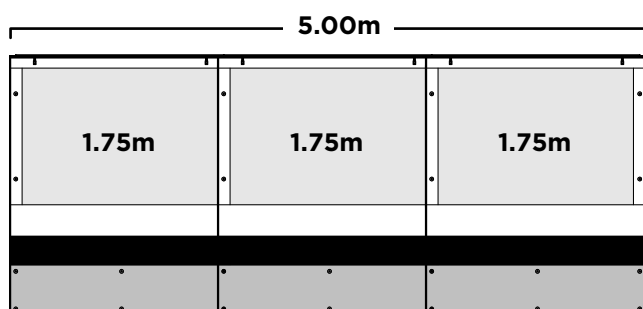
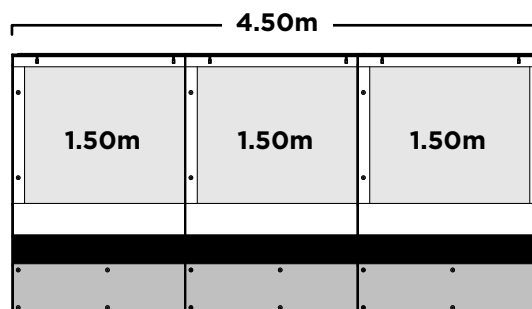
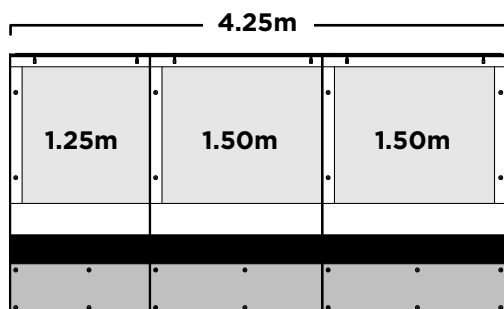
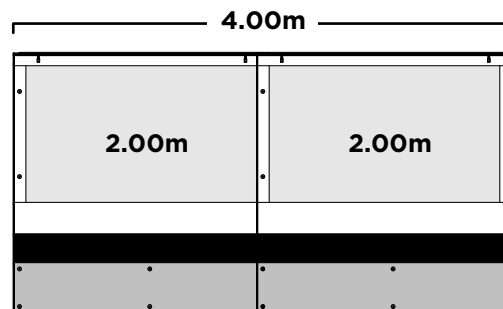
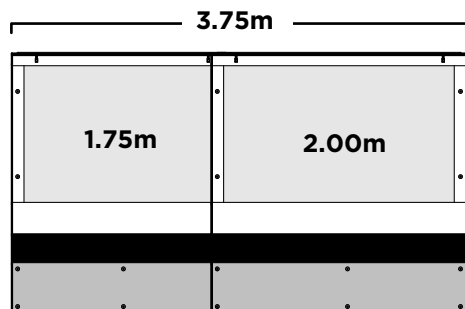
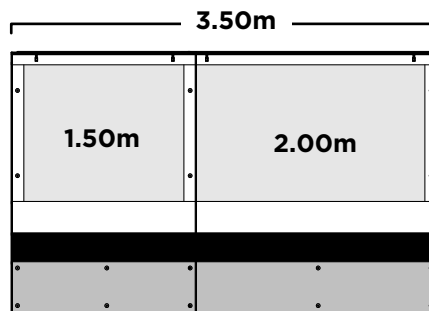
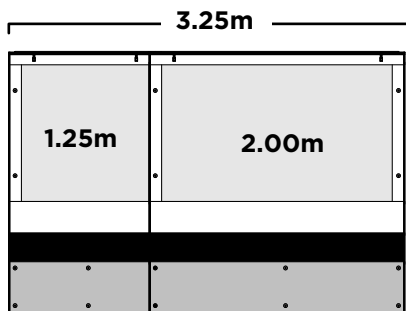
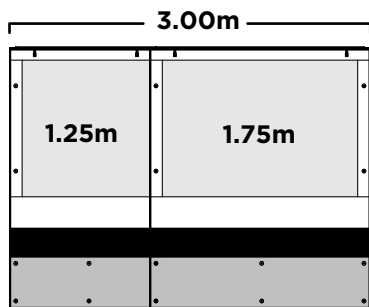

EN

Read the instructions carefully. Wrong installation, use or repair voided warranty. If recovery is needed, consult a dealer.

General remarks

- Check if the supplied product suits the type, height, and the projection of the canopy.
- The sun can affect colors depending on usage.
- When it rains, put one side of the awning lower so that the water can drain.
- When wind reaches 6 Bft. please store the panels and close the awning.
- Don't place heat sources near the walls or the roof.

Maintenance

- Ensure that there are no hard objects on the window during folding. This is to prevent impressions.
 - Let the panel dry thoroughly before long time storage.
 - Use pure water or a dry brush to clean the panel.
-

NL

Lees deze montage instructies aandachtig. Bij verkeerde montage, gebruik of eigenhandig herstel vervalt elke aanspraak op garantie. Indien herstel nodig is, raadpleeg een Dealer.

Algemene opmerkingen

- Controleer vooraf of het geleverde product past bij het type, de hoogte en de uitval van de luifel.
- De zon kan kleuren aantasten afhankelijk van het gebruik.
- Zet bij regen één kant van de luifel wat lager zodat het water kan aflopen.
- Vanaf windkracht 6 Bft. gelieve de panelen op te bergen en uw luifel te sluiten.
- Geen warmtebronnen in de buurt van de wanden of het dak plaatsen.

Onderhoud

- Zorg ervoor dat er geen harde voorwerpen op de ruit liggen tijdens het opvouwen. Dit om afdrucken te voorkomen.
 - Laat de panelen goed drogen alvorens op te bergen voor langere tijd.
 - Gebruik zuiver water of een droge borstel om de panelen te reinigen.
-

DE

Bitte lesen Sie die Montagevorschriften gründlich durch. Beiverkehrter Montage oder Änderung des Produkts entfallen alle Garantieansprüche. Im Falle von Reparaturen wenden Sie sich bitte an Ihren Fachhändler.

Allgemeine Bemerkungen

- Überprüfen Sie dass das gelieferte Produkt korrespondiert mit dem Markisentyp, Höhe und Auszug.
- Die Sonne kann Farben beeinflussen je nach Gebrauch
- Stellen Sie die Markise schräg für einen besseren Wasserablauf.
- Ab Windstärke 6 : das Produkt abbauen und die Markise einfahren.
- Keine Wärmequellen in der Nähe der Wände oder das Dach setzen.

Unterhalt

- Vermeiden Sie beim Falten dass sich keine harten Gegenstände oder Schmutz mit einrollen. Es kann Abdrücke verursachen auf die Fensterfolie.
 - Lassen Sie den Wand gut austrocknen vor dem zusammenfallen für längere Zeit.
 - Benützen Sie nur sauberes Wasser und eine trockene weiche Bürste um das Produkt zu reinigen.
-

FR

Lisez attentivement les notices d'installation. Une mauvaise installation, utilisation ou propre réparation annule toute garantie. Si la réparation est nécessaire veuillez consulter votre revendeur.

Remarques générales

- Vérifiez si le panneau fourni correspond au type, hauteur et avancé du store.
- Dépendant de l'utilisation le soleil peut affecter le coloris de la toile
- Abaissez un pied de store pour obtenir un meilleur écoulement de l'eau en cas de pluie.
- À partir d'une force de vent de 6 Bft démontez le panneau et fermez le store.
- Ne placez aucune source de chaleur près des murs ou du toit.

Maintenance

- Assurez-vous qu'il n'y a pas d'objets extérieurs sur la fenêtre lors du repliage. Ceci afin d'éviter des encoches dans la toile.
- Laissez sécher la toile complètement avant de la ranger de longue durée.
- Utilisez de l'eau claire ou une brosse sèche pour nettoyer.