

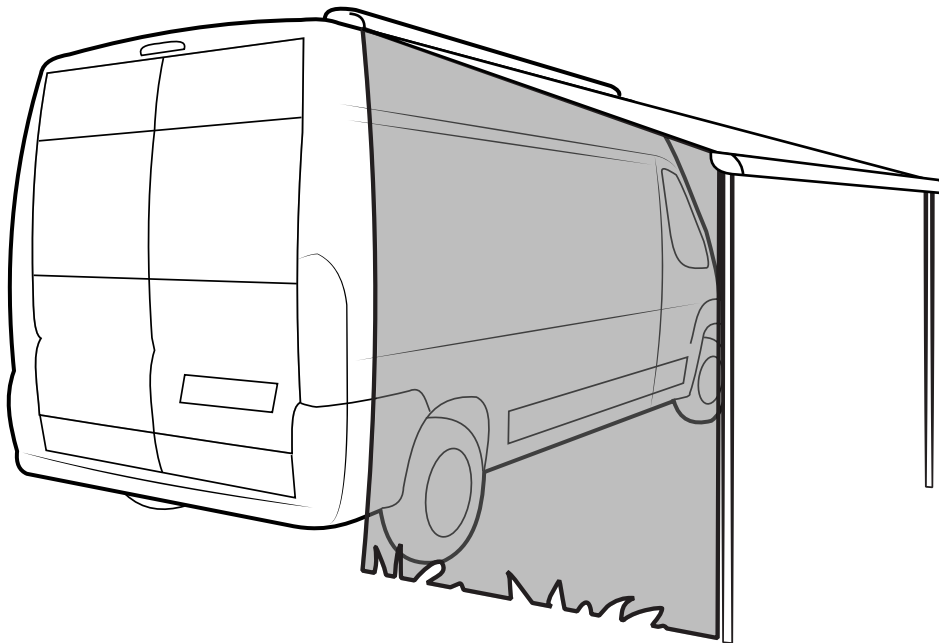

**Thule Smart Panels:  
2.50m Rain Blocker Side  
for Ducato**

# ➤ Instructions

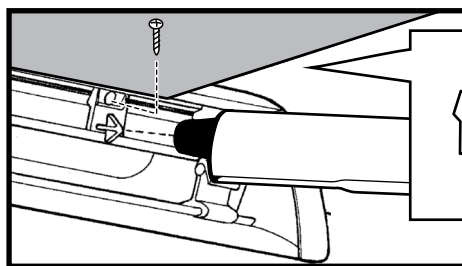

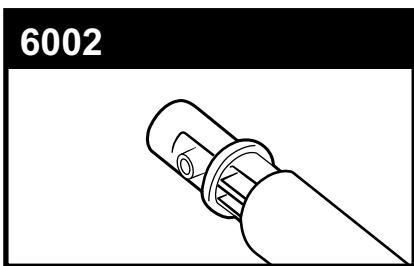
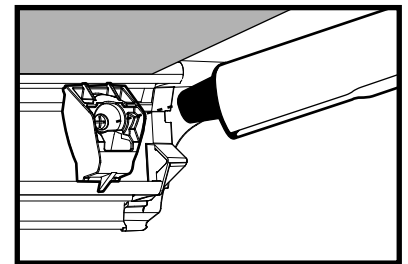
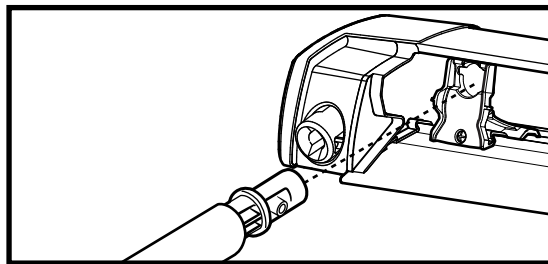
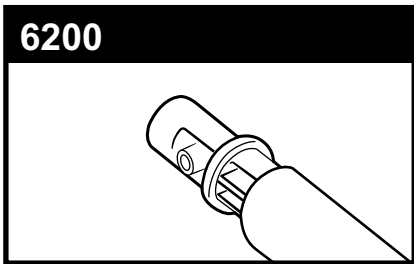
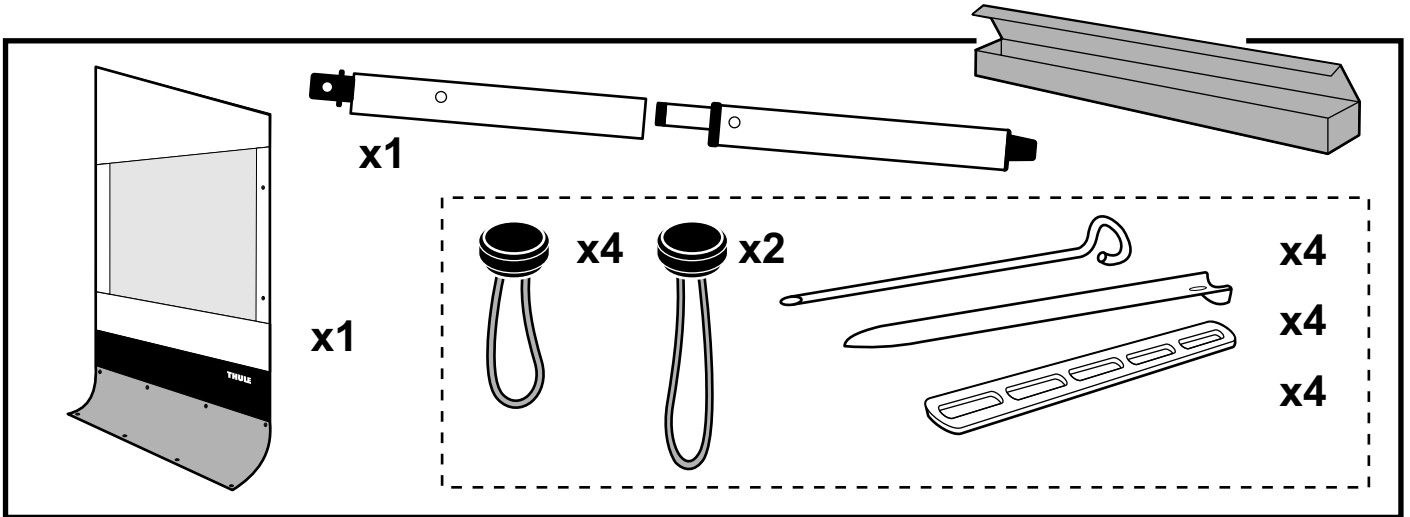

Sparepart  
  
 1500601158

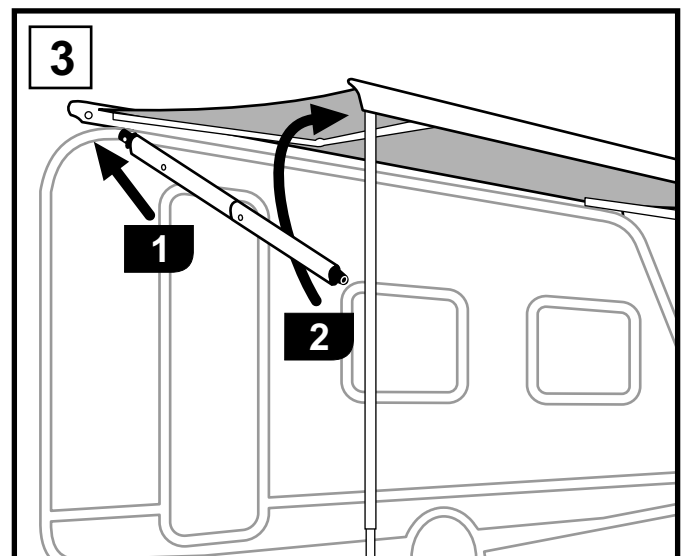
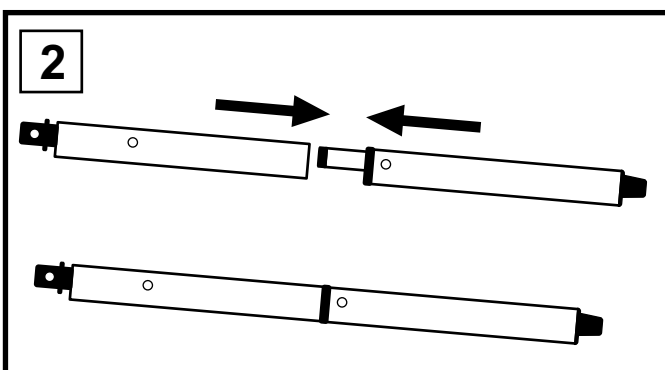
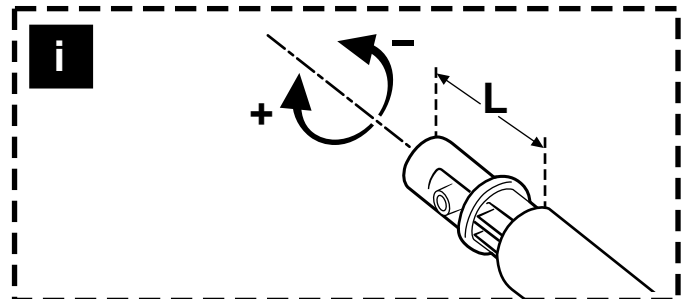
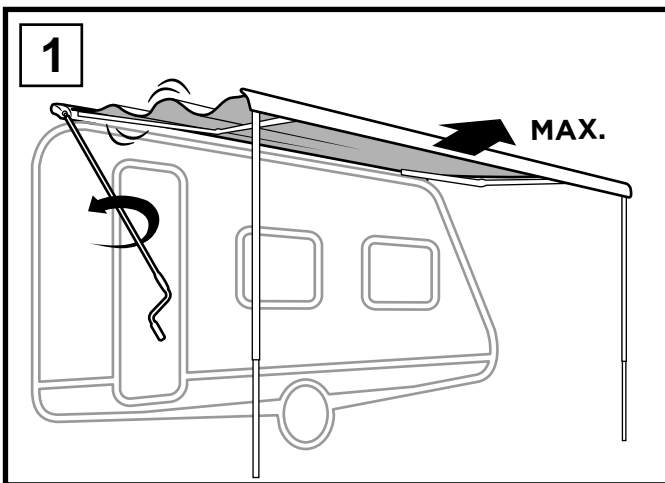
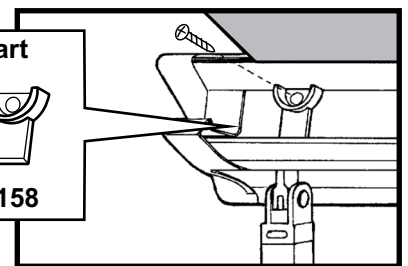

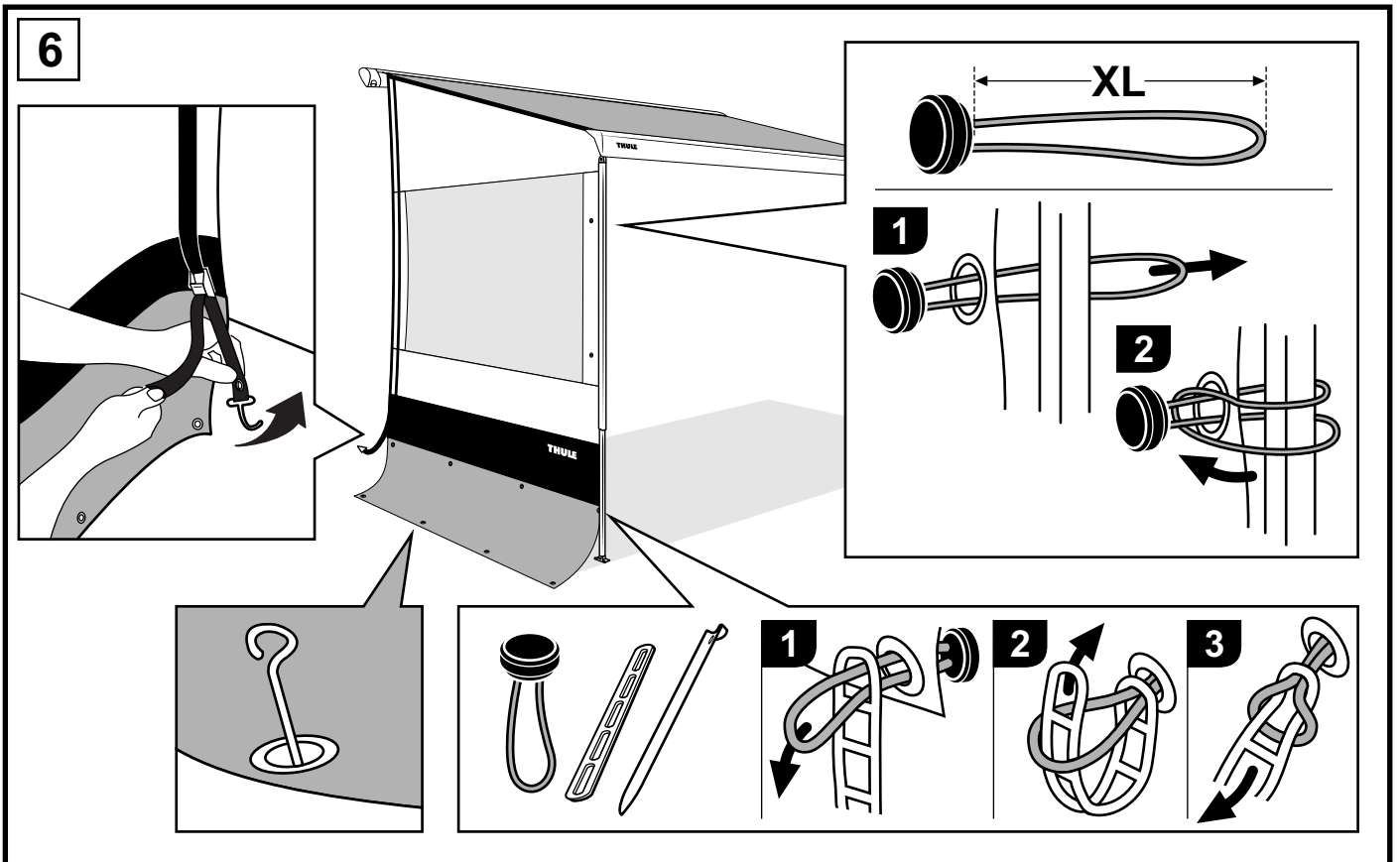
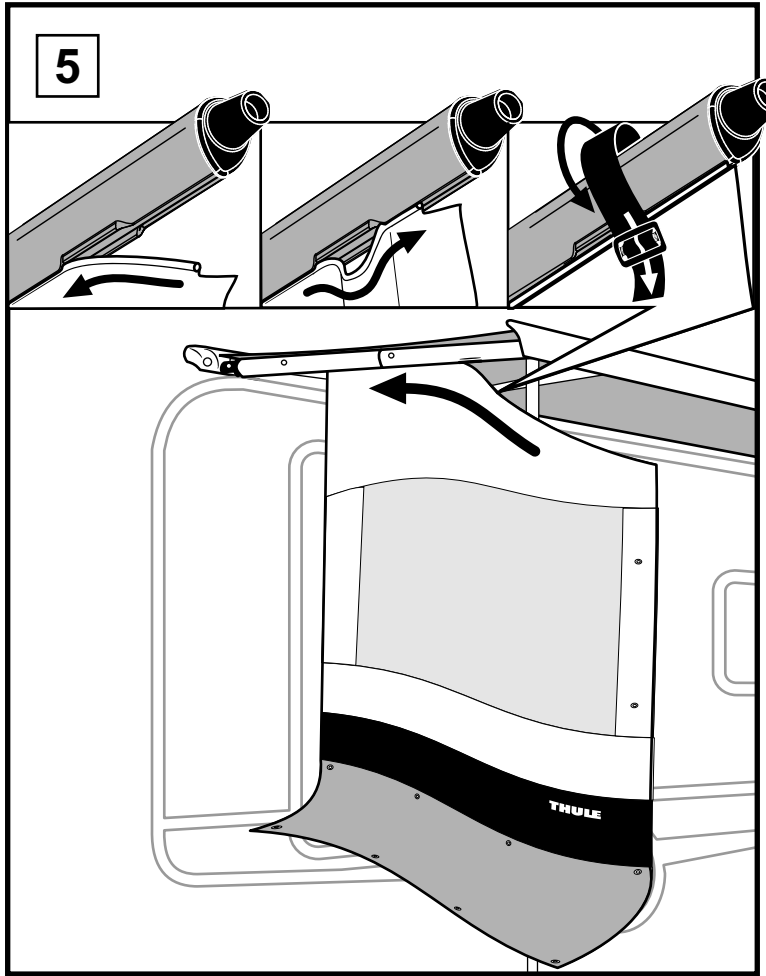
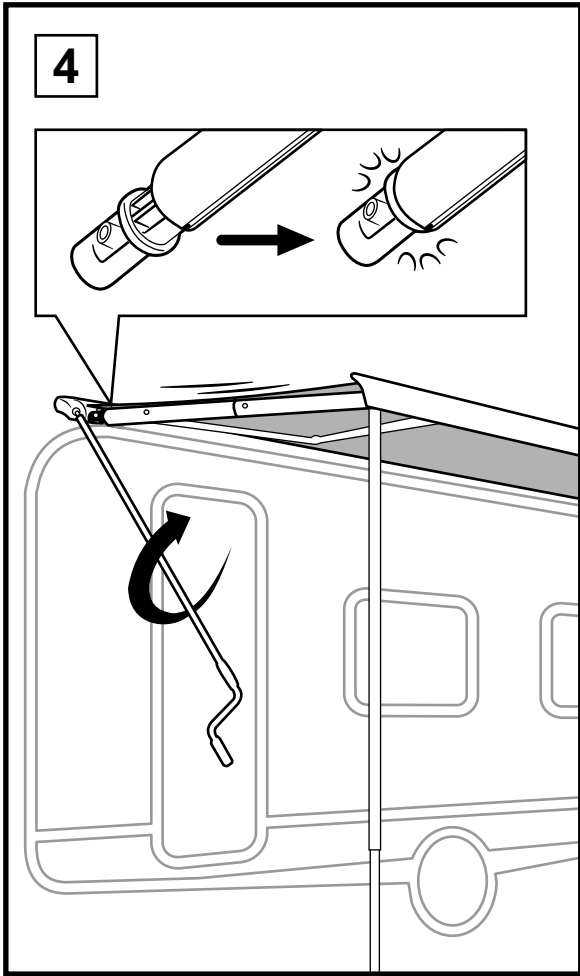

# Smart Panels: some possible combinations

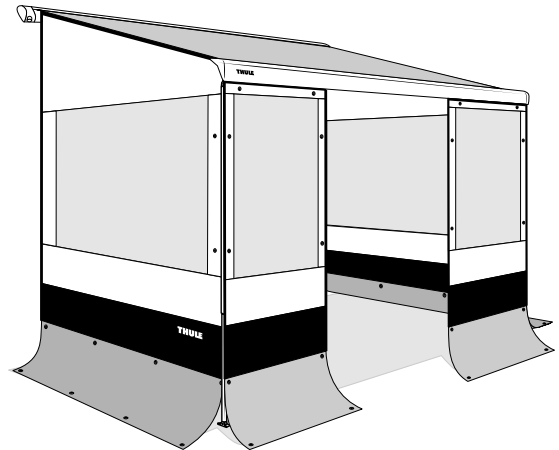
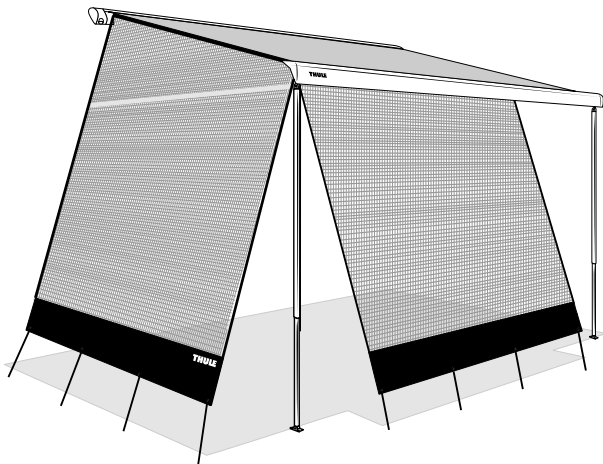
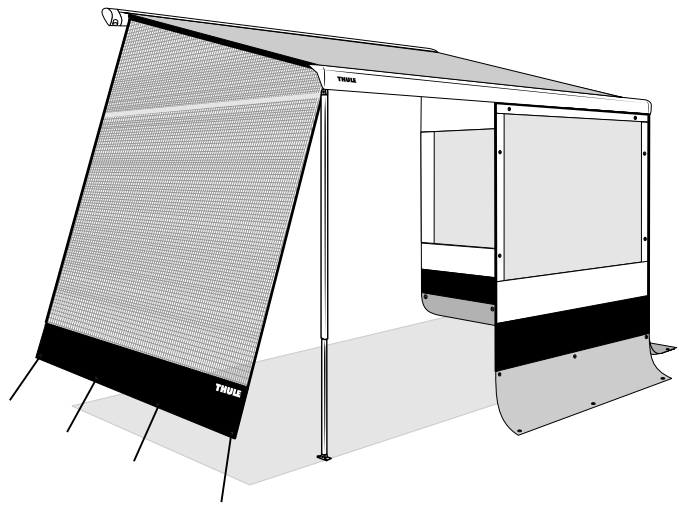
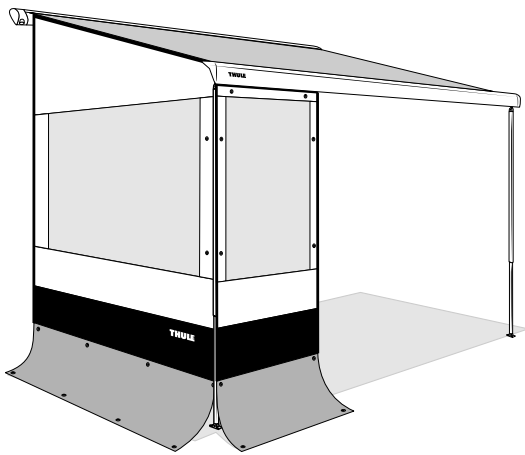
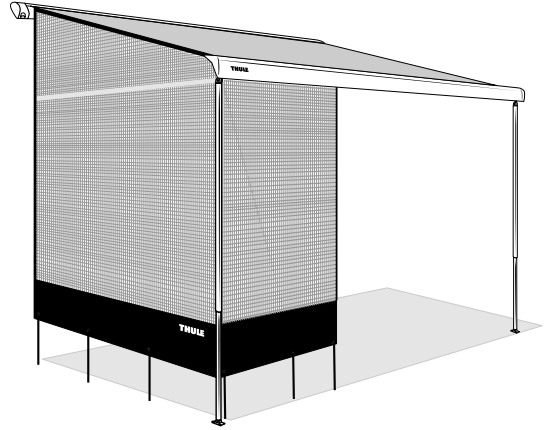
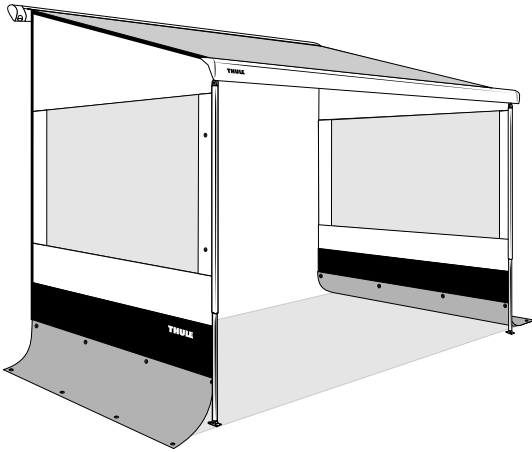

**Front**

**G2 Rain Blocker  
G2 Sun Blocker**

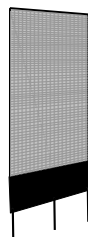
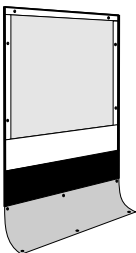

**Side**

**G2 Rain Blocker  
G2 Sun Blocker**

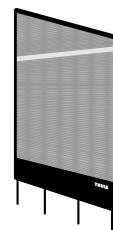
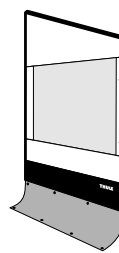

# Smart Panels: some possible combinations

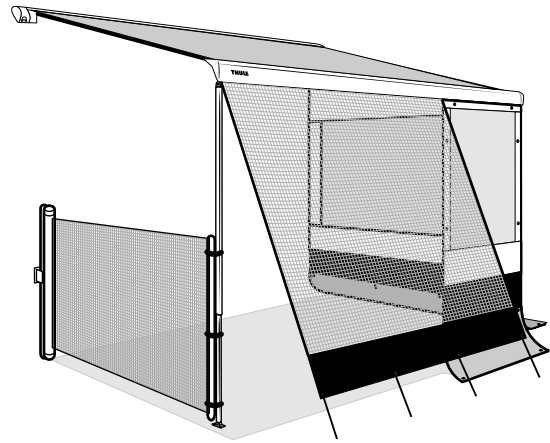
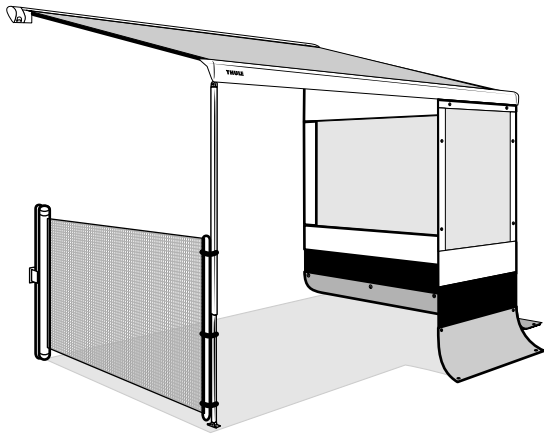

[www.thule.com](http://www.thule.com)

**306456**

**Windscreen**

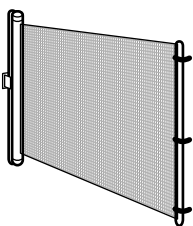

**Tent**

**QuickFit**

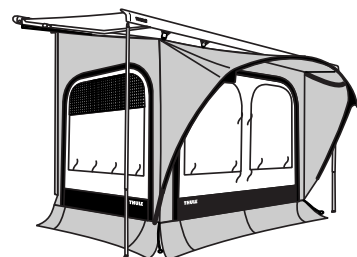

# Thule Rain Blocker Front G2

Combinations for full awning length

## Medium, Large, X-Large and XX-Large

*In combination with side panels Medium, Large, X-Large and XX-Large*

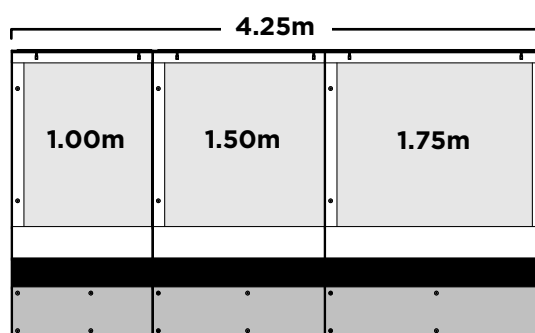
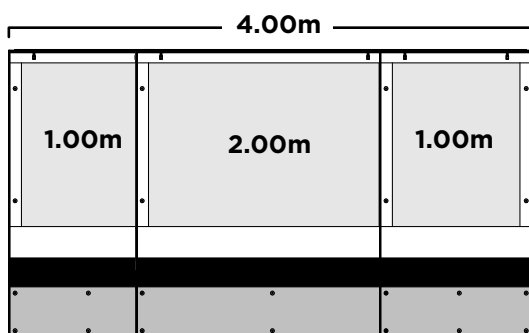
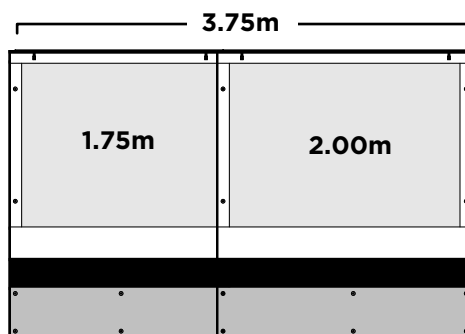
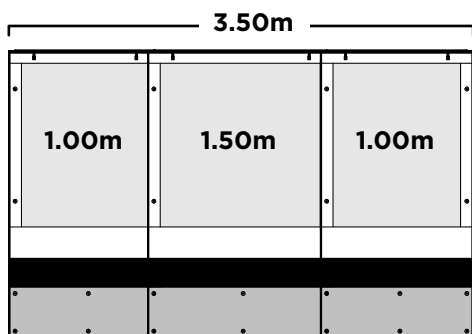
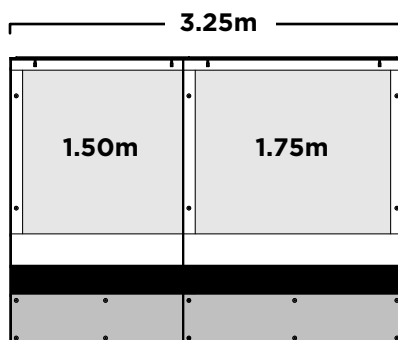
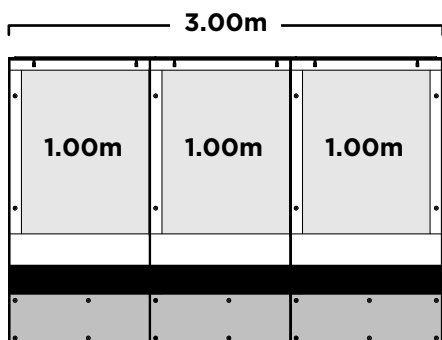

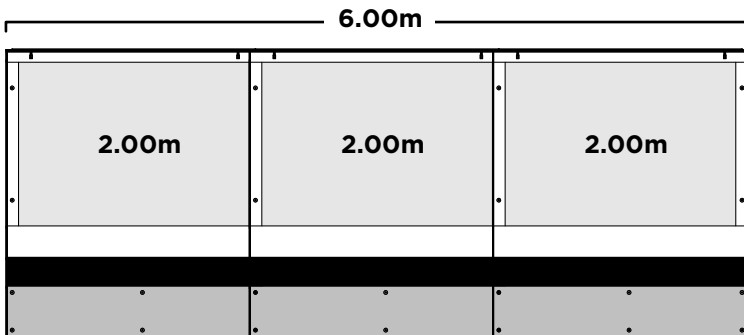
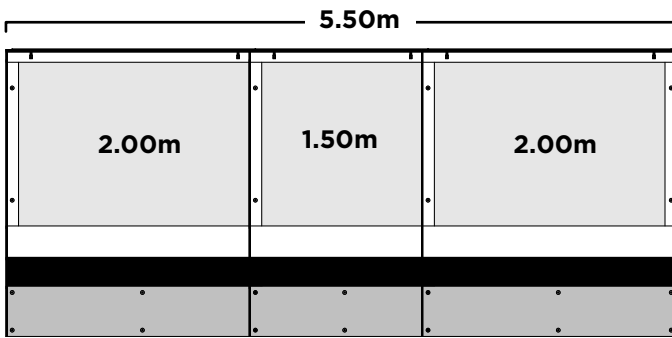
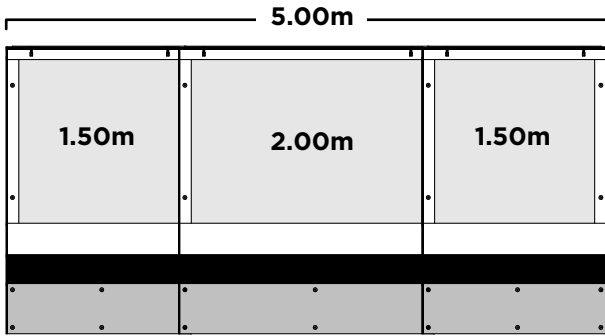
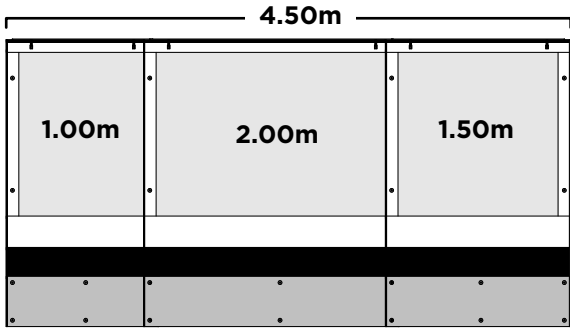

## EN

Read the instructions carefully. Wrong installation, use or repair voided warranty. If recovery is needed, consult a dealer.

### General remarks

- Check if the supplied product suits the type, height, and the projection of the canopy.
- The sun can affect colors depending on usage.
- When it rains, put one side of the awning lower so that the water can drain.
- When wind reaches 6 Bft. please store the panels and close the awning.
- Don't place heat sources near the walls or the roof.

### Maintenance

- Ensure that there are no hard objects on the window during folding. This is to prevent impressions.
  - Let the panel dry thoroughly before long time storage.
  - Use pure water or a dry brush to clean the tent.
- 

## NL

Lees deze montage instructies aandachtig. Bij verkeerde montage, gebruik of eigenhandig herstel vervalt elke aanspraak op garantie. Indien herstel nodig is, raadpleeg een Dealer.

### Algemene opmerkingen

- Controleer vooraf of het geleverde product past bij het type, de hoogte en de uitval van de luifel.
- De zon kan kleuren aantasten afhankelijk van het gebruik.
- Zet bij regen één kant van de luifel wat lager zodat het water kan aflopen.
- Vanaf windkracht 6 Bft. gelieve de panelen op te bergen en uw luifel te sluiten.
- Geen warmtebronnen in de buurt van de wanden of het dak plaatsen.

### Onderhoud

- Zorg ervoor dat er geen harde voorwerpen op de ruit liggen tijdens het opvouwen. Dit om afdrukken te voorkomen.
  - Laat de panelen goed drogen alvorens op te bergen voor langere tijd.
  - Gebruik zuiver water of een droge borstel om de panelen te reinigen.
- 

## DE

Bitte lesen Sie die Montagevorschriften gründlich durch. Bei verkehrter Montage oder Änderung des Produkts entfallen alle Garantiesprüche. Im Falle von Reparaturen wenden Sie sich bitte an Ihren Fachhändler.

### Allgemeine Bemerkungen

- Überprüfen Sie dass das gelieferte Produkt korrespondiert mit dem Markisentyp, Höhe und Auszug.
- Die Sonne kann Farben beeinflussen je nach Gebrauch
- Stellen Sie die Markise schräg für einen besseren Wasserablauf.
- Ab Windstärke 6 : das Produkt abbauen und die Markise einfahren.
- Keine Wärmequellen in der Nähe der Wände oder das Dach setzen.

### Unterhalt

- Vermeiden Sie beim Falten dass sich keine harten Gegenstände oder Schmutz mit einrollen. Es kann Abdrücke verursachen auf die Fensterfolie.
  - Lassen Sie den Wand gut austrocknen vor dem zusammenfalten für längere Zeit.
  - Benützen Sie nur sauberes Wasser und eine trockene weiche Bürste um das Produkt zu reinigen.
- 

## FR

Lisez attentivement les notices d'installation. Une mauvaise installation, utilisation ou propre réparation annule toute garantie. Si la réparation est nécessaire veuillez consulter votre revendeur.

### Remarques générales

- Vérifiez si le panneau fourni correspond au type, hauteur et avancé du store.
- Dépendant de l'utilisation le soleil peut affecter le coloris de la toile
- Abaissez un pied de store pour obtenir un meilleur écoulement de l'eau en cas de pluie.
- À partir d'une force de vent de 6 Bft démontez le panneau et fermez le store.
- Ne placez aucune source de chaleur près des murs ou du toit.

### Maintenance

- Assurez-vous qu'il n'y a pas d'objets extérieurs sur la fenêtre lors du repliage. Ceci afin d'éviter des encoches dans la toile.
- Laissez sécher la toile complètement avant de la ranger de longue durée.
- Utilisez de l'eau claire ou une brosse sèche pour nettoyer.